

VIDMUX® Series

SE-15V-xx-L/RS

SE-AV-xx-L/RS

4, 8, or 16 Port VGA Video-Only / Audio-Video Switch Installation and Operation Manual



Front and Rear View of SE-15V-8-L



Front and Rear View of SE-AV-8-RS

TRADEMARK

VIDMUX is a registered trademark of Network Technologies Inc in the U.S. and other countries.

COPYRIGHT

Copyright © 1998, 2008 by Network Technologies Inc. All rights reserved. No part of this publication may be reproduced, stored in a retrieval system, or transmitted, in any form or by any means, electronic, mechanical, photocopying, recording, or otherwise, without the prior written consent of Network Technologies Inc, 1275 Danner Drive, Aurora, Ohio 44202.

CHANGES

The material in this guide is for information only and is subject to change without notice. Network Technologies Inc reserves the right to make changes in the product design without reservation and without notification to its users.

TABLE OF CONTENTS

Introduction	1
Materials	1
Features and Functions	2
Rack-Mounting	3
To Mount to a Rack	3
Installation	4
Cable Connections	4
RS232 Control	4
Audio Connections (SE-AV-xx-L/RS only).....	5
Power Up Sequence.....	5
Local Control	6
Scan Mode.....	6
RS232 Control	7
RS232 Connections and Configuration	7
Remote Connection	7
Baud Rate	7
Unit Address	8
Loop Back Dipswitch	8
Command Protocol.....	9
Autostatus.....	10
Scan Mode.....	10
NTI Switch Control Program For Windows 9X, NT, 2000, XP and Vista	10
SerTest- RS232 Interface Test Program	11
Main Options.....	11
Matrix Operations.....	11
Setup Options	11
Audio Support	12
Specifications For Straight-Through RS232 Serial Cable	12
Technical Specifications	12
Troubleshooting	13
Index	14
Warranty Information	14

TABLE OF FIGURES

Figure 1- Secure rackmount ears to switch.....	3
Figure 2- Secure switch to a rack	3
Figure 3- Make cable connections to the VIDMUX	4
Figure 4- Audio connections for VIDMUX with audio support	5
Figure 5- View of Front of VIDMUX with Local Control	6
Figure 6- RS232 connection with Matrix-Y-1 cable	8
Figure 7- Pinout of Matrix-Y-1 cable	8

INTRODUCTION

The VIDMUX® VGA video switch enables up to 4/8/16 video sources to be connected to a single video monitor, projector or plasma screen. VIDMUX Switches are made with either local video connection control with push buttons on the VIDMUX switch, or with remote video connection control with an RS232 connection port on the VIDMUX switch.

Models covered by this manual include:

SE-15V-4-L	SE-15V-8-L	SE-15V-16-L	SE-AV-4-L	SE-AV-8-L	SE-AV-16-L
SE-15V-4-RS	SE-15V-8-RS	SE-15V-16-RS	SE-AV-4-RS	SE-AV-8-RS	SE-AV-16-RS

Legend:

-15V= Switches with video-only support

-AV= Switches with video and audio support

-L = Switches support local video connection control

-RS= Switch supports remote video connection control (RS232)

Features:

- Compatible with PCs, SUNs and MACs with VGA video.
- Eliminate redundant monitors.
- Ideal for classrooms and boardrooms.
- Interconnect NTI switches & splitters for complex applications.
- Crisp and clear 1900 x 1200 video resolution at 60Hz

Materials

Materials Included with this kit:

- NTI SE-15V-4/8/16-L/RS 4,8, or 16 port VGA Video-only Switch
or
- NTI SE-AV-4/8/16-L/RS 4,8, or 16 port VGA Audio-Video Switch
- Line cord- country specific
- VEXT-3-MM 3 foot 15HD male to 15HD male video cable
- SA-3-MM 3 foot 3.5mm plug-to-plug stereo audio cable (models with audio support only)
- 2- Rack-mount ears (4 and 8 port models only)
- 6- #6-32x3/16" screws (for attachment of ears on 4 and 8 port models)
- 4- rubber feet (4 and 8 port models only)
- CD with pdf file of this manual and RS232 Control Software (software only used in models with "-RS")

FEATURES AND FUNCTIONS

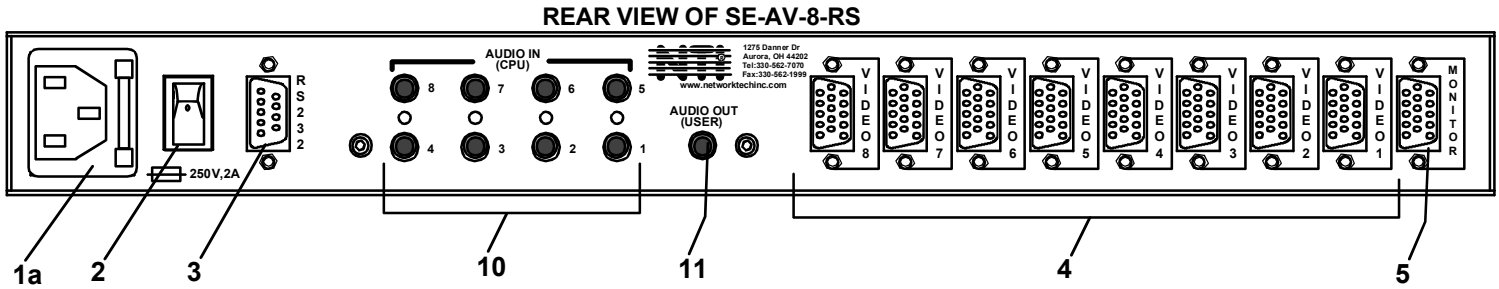
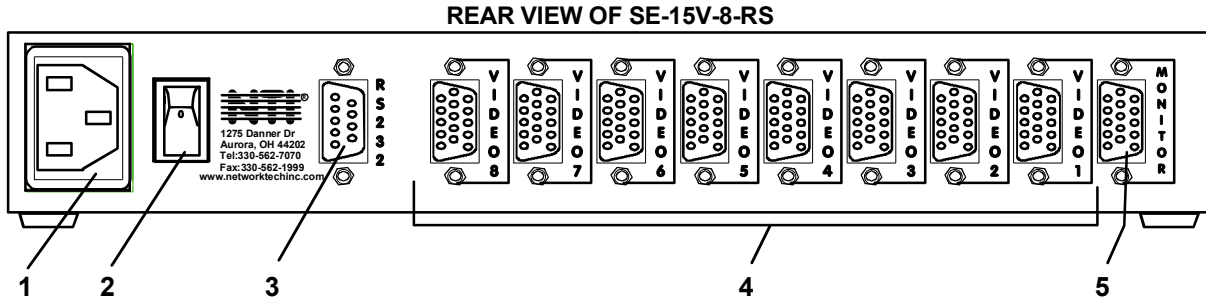
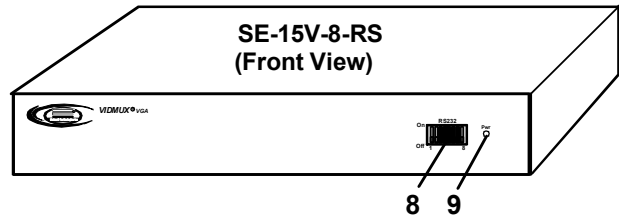
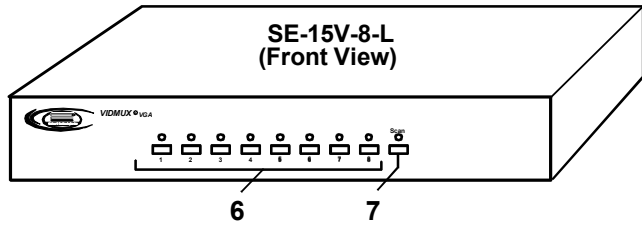

1. **IEC Cord Connector**- for attachment of the country-specific power cord
- 1a. **IEC Connector w/Built-in 2A 240VAC Replaceable Fuse**- for attachment of the country-specific power cord (only in models with audio support)
2. **Power switch**- used to power the VIDMUX ON/OFF
3. **RS232- 9DB female connector**- for attachment of a serial cable for RS232 control (only on models ending in “-RS”)
4. **Video-x- 15HD female connectors**- for connection of video cable from video source(s)
5. **Monitor**- 15HD female connector- for connection of video cable from user monitor
6. **CPU Buttons & LEDs**- used to select and indicate connection to desired video source (only on models ending in “-L”)
7. **Scan Button & LED**- used to toggle Scan mode ON and OFF (only on models ending in “-L”)
8. **RS232 Dip switches**- for configuring RS232 control connection (only on models ending in “-RS”)
9. **Pwr LED**- to indicate power has been applied to the VIDMUX (only on models ending in “-RS”)
10. **Audio IN (CPU)**- 3.5MM Jack-for connection of audio cables from audio sources (only in models with audio support)
11. **Audio OUT (USER)**- 3.5MM Jack- for connection of audio cables to audio output devices (speakers)(only in models with audio support)

RACK-MOUNTING

This NTI switch was designed to be mounted to a rack or to set on a desktop. It includes rackmount ears to make attachment to a rack easy, and rubber feet to be applied to the bottom of the case if it will instead sit on a flat surface. If this will sit on a flat surface, simply apply the rubber feet to the bottom of the case in each of the 4 corners.

To Mount to a Rack

1. Attach the ears to the switch using the 6-32x3/16" flat Phillips-head screws (6) provided as shown in the illustration below. The holes in the ears should line up with pre-threaded holes in the sides of the NTI switch. Tighten the screws securely.

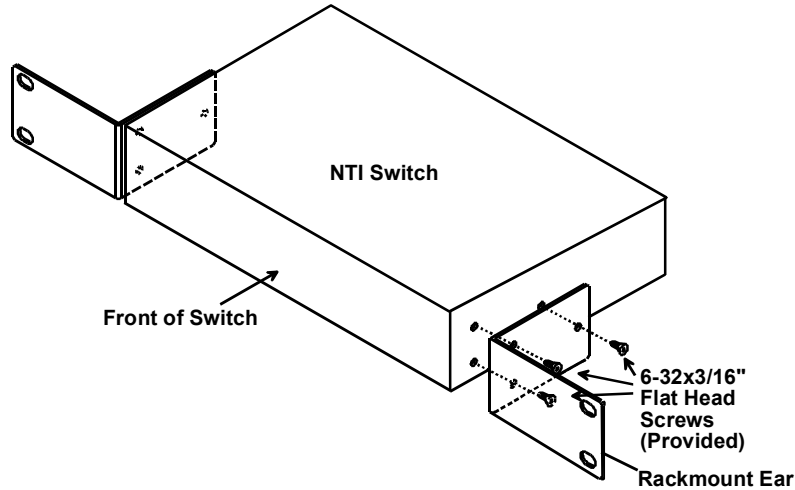

Figure 1- Secure rackmount ears to switch

2. Install 4 captive nuts (not provided) to the rack in locations that line up with the holes in the mounting ear on the NTI switch.
3. Secure the NTI switch to the rack using four screws (typically #10-32 x 3/4"- not provided). Each screw should be of sufficient length to go completely through the NTI mounting ear, rack frame and fully engage all threads in the captive nut. Be sure to tighten all mounting screws securely.
4. Attach all cables securely to the switch and where necessary supply adequate means of strain relief for cables.

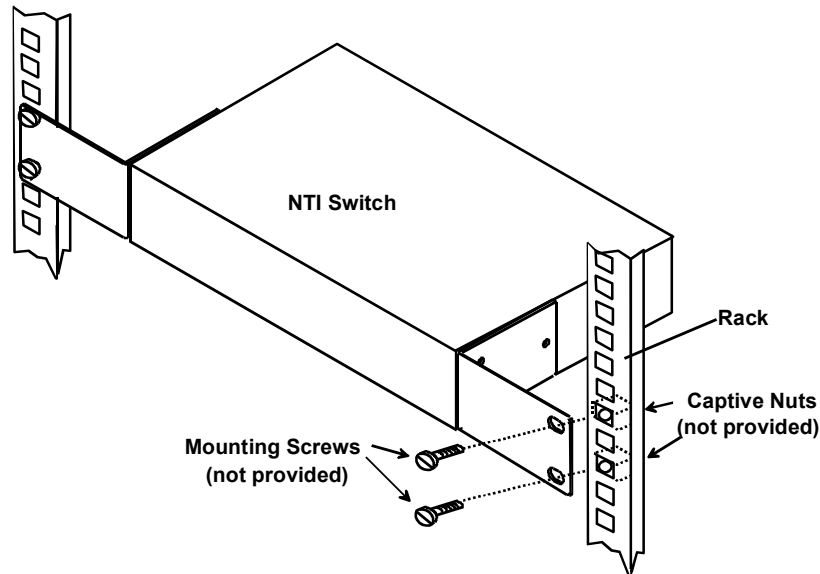

Figure 2- Secure switch to a rack

INSTALLATION

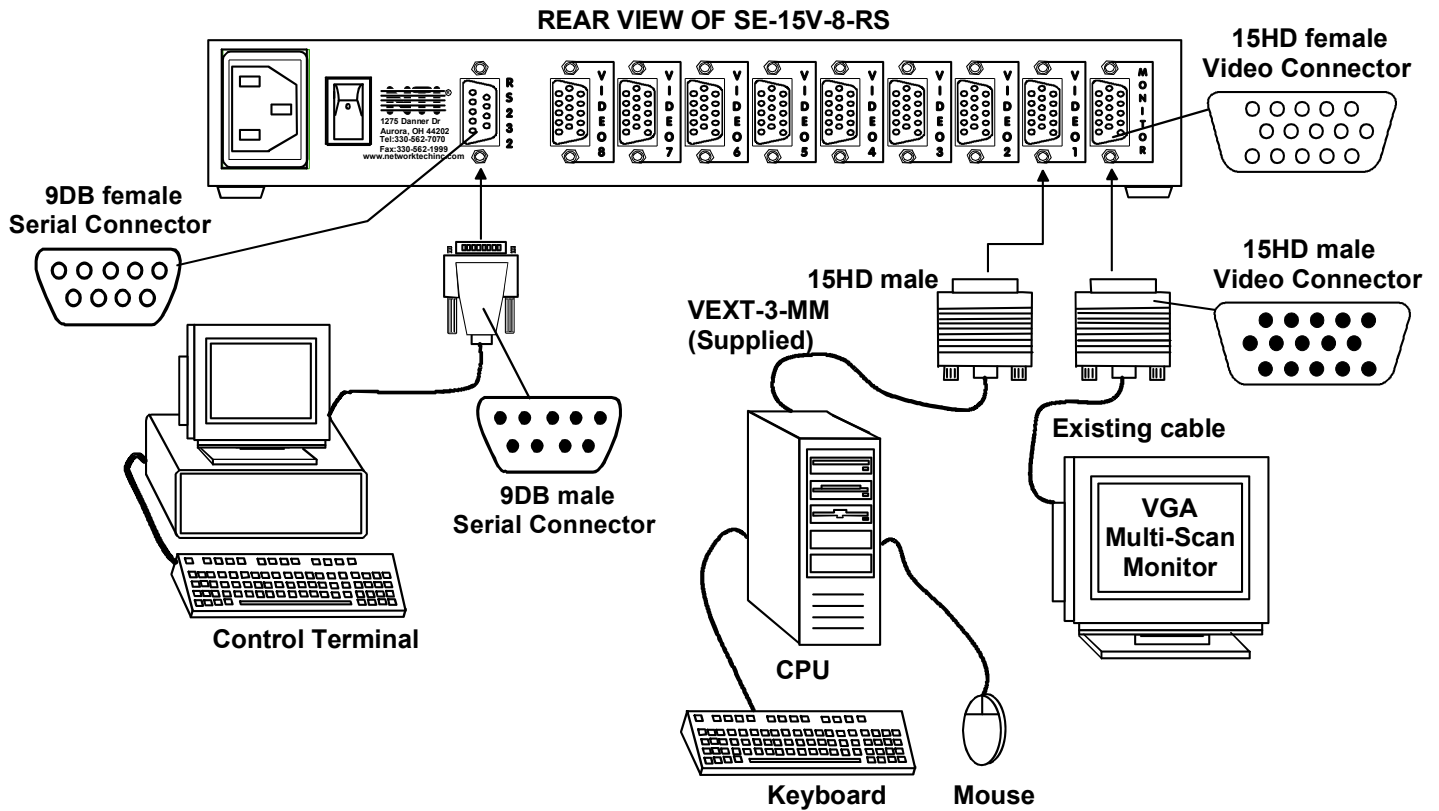

Figure 3- Make cable connections to the VIDMUX

Cable Connections

1. Turn OFF power to video source(s) and monitor(s).
2. Connect the supplied VEXT-3-MM cable between the video port on a video source and the “VIDEO 1” connector on the VIDMUX.
3. Connect video cables from additional video sources to the remaining “VIDEO x” ports on the VIDMUX.

FYI: Additional VEXT cables are available from NTI in 1.5, 3, 6, 10, 15, 25, 35, 50, 75 and 100 foot lengths.

4. Connect VGA monitor to the “MONITOR” connector on the VIDMUX.
5. Connect the IEC power cord to the IEC connector.

RS232 Control

(Applicable to models ending in “-RS” only)

RS232 control can be achieved using a separate user terminal or CPU with a terminal program. To make a terminal connection, connect a serial cable (specifications on page 12) between the user terminal and the 9 pin DIN female connector on the VIDMUX labeled “RS232”. (See Fig. 3)

Audio Connections (SE-AV-xx-L/RS only)

Models with audio support (SE-AV-xx-L/RS) have 3.5mm jacks for connection to audio sources (“AUDIO IN”) and an audio output device (“AUDIO OUT”).

1. Connect an audio output device (speakers) to the “AUDIO OUT” port on the VIDMUX.
2. Connect the supplied SA-3-MM cable from the audio port on the CPU to the “AUDIO IN” port on the VIDMUX.

FYI: Additional SA-xx-MM cables are available from NTI in 6,10, 15, 25, 35, 50 and 100 foot lengths.

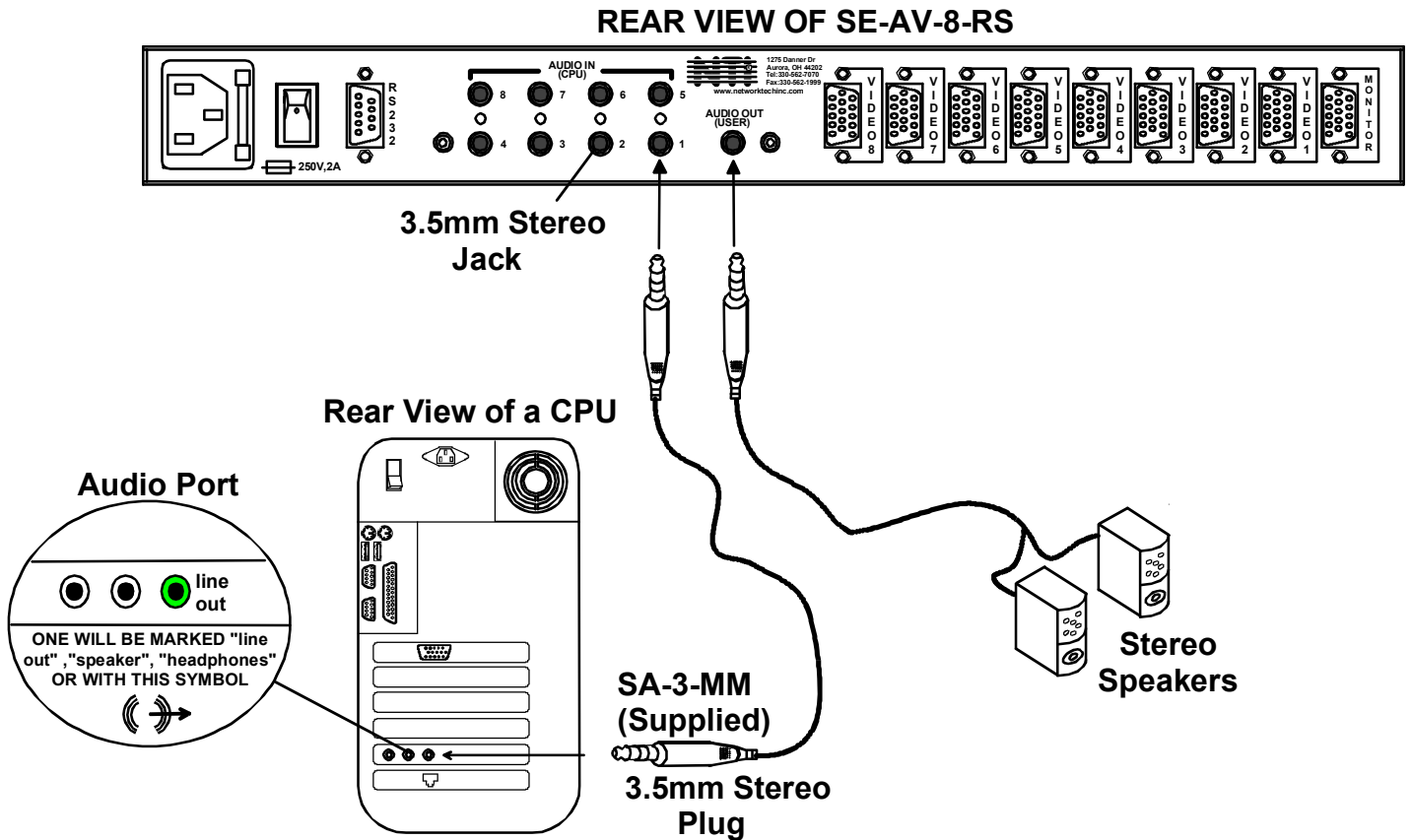

Figure 4- Audio connections for VIDMUX with audio support

Power Up Sequence

1. Power ON the VIDMUX.
2. Power ON the user monitor.
3. Power ON each video source connected.

LOCAL CONTROL

Note: RS232 Control is not available when the Local Control option is present.

The VIDMUX with model number ending in “-L” is equipped with switches for local control over video connections between the user and the connected video source. With a video source connected to a numbered video port on the rear of the VIDMUX, simply press the button associated with the video source to view the video from that video source on the user’s monitor. As long as the VIDMUX is not in Scan Mode (below), the user will remain connected until another button is pressed.

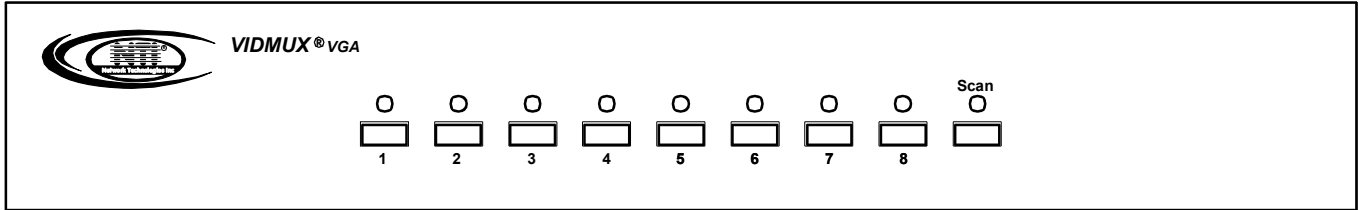

Figure 5- View of Front of VIDMUX with Local Control

Scan Mode

Models with Local Control also have the feature Scan Mode. Scan Mode causes an output port to automatically switch from one input port to the next consecutive input port after a 5 second pause. If a video source is connected to the input port, the video will be viewed for 5 seconds before switching again. Port switching will continue indefinitely and no ports will be skipped, whether there are video sources connected to them or not.

RS232 CONTROL

Note: Local Control is not available when the RS232 Control option is present.

RS232 Connections and Configuration

Models ending in “-RS” include a 9DB female serial connector on the rear of the switch for connection to a terminal or device with a terminal program. Using a cable wired straight-through (not “null modem” –see specs on page 11), connect a terminal to the VIDMUX and configure the terminal program. Configure the terminal program and VIDMUX for a baud rate between 300 and 9600 as instructed below.

Remote Connection

The RS232 Interface is designed to meet the RS232C standard and can be controlled from any CPU or other controller with an RS232 communications port. The pin-out for the 9DB connector on the unit is as follows:

RS232 CONNECTOR (9DB FEMALE)

PIN	SIGNAL	FUNCTION
1	CD	Carrier Detect
2	TXD	Transmit data (RXD at host)
3	RXD	Receive data (TXD at host)
4	DTR	Data terminal ready
5	GND	Signal ground
6	DSR	Data set ready
7	RTS	Request to send
8	CTS	Clear to send
9	-	No connection

On the 9DB female connector, pins 1 (DCD), 4 (DTR), and 6 (DSR) are shorted and pins 7 (RTS) and 8 (CTS) are shorted. Therefore, host handshaking is bypassed and TXD and RXD are the only active signals. A straight-through 9DB serial cable (**not null modem- see specifications on page 12**) will work for most CPUs. To daisy chain multiple units, a Matrix Y-1 cable is used (see page 8) for each VIDMUX in the chain.

Baud Rate

The baud rate can be changed either using the RS232 Command Protocol (page 8) or by powering down the unit, changing the 8 position RS232 dip switch on the front of the VIDMUX, and then powering back up. The table below shows how to set the baud rate. The default positions are 2,3 and 4 ON as shown in gray.)

Note: The baud rate as configured by the dip switches will be the set baud rate each time the VIDMUX is power cycled, regardless of what the baud rate is changed to via the RS232 Command Protocol.

DIP SWITCH			BAUD RATE
4	3	2	
OFF	OFF	OFF	300
OFF	OFF	ON	600
OFF	ON	OFF	1200
OFF	ON	ON	2400
OFF	OFF	OFF	4800
ON	OFF	ON	9600 (default)
ON	ON	OFF	
ON	ON	ON	

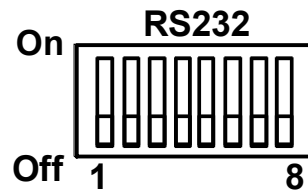

Unit Address

To allow multiple units to be controlled from a single CPU port, the RS232 control interface is designed to allow "daisy chaining" up to 15 units. By setting the appropriate RS232 dip switches, each unit can be given a unique address (1-15). Then the unit will only respond to commands on the bus if its address is embedded in the command. Use the table below to set the unit address. The default switch positions are 5 ON, 6 OFF, 7 OFF, and 8 OFF (shown in gray).

DIP SWITCH				UNIT ADDRESS
8	7	6	5	
OFF	OFF	OFF	OFF	0 (not valid)
OFF	OFF	OFF	ON	1 (default)
OFF	OFF	ON	OFF	2
OFF	OFF	ON	ON	3
OFF	ON	OFF	OFF	4
OFF	ON	OFF	ON	5
OFF	ON	ON	OFF	6
OFF	ON	ON	ON	7
ON	OFF	OFF	OFF	8
ON	OFF	OFF	ON	9
ON	OFF	ON	OFF	10
ON	OFF	ON	ON	11
ON	ON	OFF	OFF	12
ON	ON	OFF	ON	13
ON	ON	ON	OFF	14
ON	ON	ON	ON	15

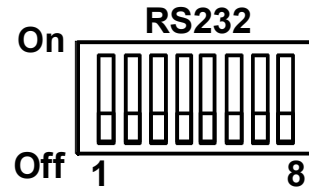

Loop Back Dipswitch

Dipswitch 1 is the Loop Back dipswitch and should always be set to ON.

Note: In order to connect multiple VIDMUX units together a Matrix-Y-1 cable must be used. (See Fig. 6.) See Fig. 7 for the pinout of the Matrix-Y-1 cable. The Matrix-Y-1 cable is available from Network Technologies Inc.

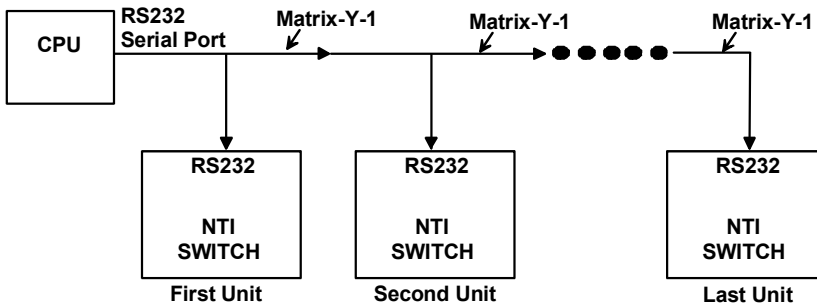

Figure 6- RS232 connection with Matrix-Y-1 cable

Wiring Schematic of Matrix-Y-1 cable

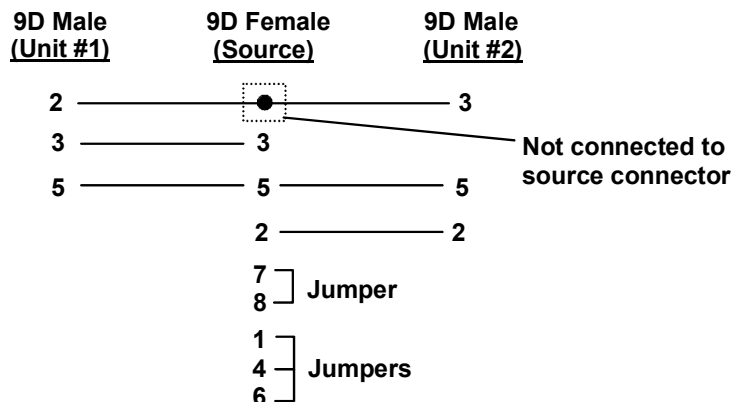

Figure 7- Pinout of Matrix-Y-1 cable

Command Protocol

CPU controller commands supported by the unit are defined below. All commands should be terminated with a <CR> (carriage return). All characters in the command string should be upper case, and all numbers below 10 should have a leading 0 (ex: 1 = 01).

Note: Alternatively, the user may use the NTI Switch Control Program or SerTest to control the VIDMUX via RS232 (see pages 10 and 11).

Legend: (All numbers must be two digits)

SW : Switch (01-15) (Unit Address)
 BR : Baud Rate Code (3,6,12,24,48,96)
 OP : Output Port (01)
 IP : Input Port (01-MAXINPUTS)
 <CR> : Carriage Return (Hex 0xD)

Command Definitions

Command String	Good Response	Description
CS SW,IP,OP	*<CR>	Connect One Output Port To Input Port
CA SW,IP	*<CR>	Connect All Output Ports To Input Port
RO SW,OP	*<CR>IP<CR>	Read Connection For Output/User Port
CB 00,BR	None	Change baud rate of serial line BR=03(00),06(00),12(00),24(00),48(00),96(00) Factory default is 9,600 (<i>see note below</i>)
RS SW	*<CR>	Internal Reset
RV SW,00	*<CR>string\0<CR>	Read NTI Version String
RU SW	*<CR>IP,OP<CR>	Read Unit Size
SS SW,00	*<CR>	Disable Autostatus feature (see page 10)
SS SW,01	*<CR>	Enable Autostatus feature (see page 10)
GO SW,OP	*<CR>go SW,OP:IP<CR>	Read connection of a Output Port to Input Port
Ss SW,OP,DWT	*<CR>	Set Scan Mode dwell time for specific Output port DWT values: 000-255 See page 10 for more info.
Gs SW,OP	*<CR> DWT<CR>	Read scan mode dwell time setting for an Output port DWT values: 000-255
Sa SW,OP	*<CR>	Add all inputs to scan list of output port
Sc SW,OP	*<CR>	Remove all inputs from scan list of output port
S+ SW,OP,IP	*<CR>	Add individual input to Scan List of output port
S- SW,OP,IP	*<CR>	Remove individual input from Scan List of output port
Sx SW,OP	*<CR>ooxoxxxxooooxxx< CR>	Inspect the Scan List (o=skip x=don't skip)
SM SW,OP	*<CR>	Toggle Scan mode ON/OFF for specific output port

If the syntax of a command is incorrectly entered, the command will be ignored or the switch will answer with a bad response ?<CR>.

Note: The baud rate as changed via RS232 will hold only until the VIDMUX is power cycled. On power-up, the VIDMUX will resume the baud rate as configured via the dipswitches on the VIDMUX (see page 7). To make a lasting baud rate change, adjust the dipswitch positions as indicated in the baud rate chart (page 7).

Autostatus

When Autostatus is enabled, any output-to-input connection change in the VIDMUX will cause an Autostatus message to be sent via RS232 to the administrator. The format of the message will be "pc SW,OP:IP<CR>"

Example of an Autostatus message:

```
pc 01,01:04<CR>
```

which means "At the switch with unit address 01, the output (01) has changed connection to input 04."

**Notes: Any message to the administrator will be delayed by any RS232 traffic being received by the switch from the administrator.
Autostatus must be disabled before using SerTest or the NTI Switch Control Program (below).**

By default, Autostatus is disabled and must be manually enabled. Autostatus is also disabled any time the power to the VIDMUX is interrupted.

Scan Mode

Scan Mode causes an output port to automatically switch from one input port to the next consecutive input port after a specified period of time (referred to as the dwell time). Port switching will continue indefinitely and no ports will be skipped, whether there are video sources connected to them or not. If desired, the VIDMUX can be configured to skip the scanning of specific ports by removing them from the scan list using the RS232 Command Protocol (page 9).

Dwell time settings can be any value from 0 seconds (000) to 255 seconds; however, a setting of 000 seconds will result in a 1 second (minimum) dwell time for that output port. The default dwell time value is 5 seconds.

NTI Switch Control Program For Windows 9X, NT, 2000, XP and Vista

The NTI Switch Control Program is an easy and powerful graphical program that controls NTI switches through an RS232 interface. The NTI Switch Control Program is included on the CD packaged with the VIDMUX. The NTI Switch Control Program is downloaded by clicking on the link "Download NTI Switch Control Program" found on the web page that appears when you insert the instruction manual CD into your CD ROM drive.

To install the NTI Switch Control Program after downloading

1. Locate the **Setup.exe** in the directory the program was downloaded to and double-click on it
2. Follow the instructions on the screen

The NTI Switch Control Program performs best on monitors set to a screen resolution of at least 800 X 600. Instruction for using the NTI Switch Control Program is available by opening "MSCP Help" in the "NTI" program group once the program has been installed and is open on the screen.

Note: The NTI Switch Control Program is used with 9600 baud rate only.

To open "MSCP Help" from the Windows desktop

1. Click on **START**
2. Click on **PROGRAMS**
3. Click on **NTI**
4. Click on **MSCP Help**

SerTest- RS232 Interface Test Program

This software allows a user to test the functions of an NTI server switch, video switch, matrix switch or Multi-user/Multi-platform switch RS232 interface. The program SERTEST along with the NTI Switch Control Program (page 10) is installed from the CD packaged with this switch. SERTEST generates a main menu with the 4 selections described below:

Main Options

- Matrix Operations - send commands to the VIDMUX.
- Ethernet Operations - set Ethernet connection variables (not applicable to VIDMUX)
- Setup Options - set COM port, baud rate, and unit address
- About SerTest - display the program version

Matrix Operations

Key	Selection	Description
1)	Connect Video Output/monitor to an Input/Source	- connect an output to an input
2)	Connect All Video Outputs/monitors to an Input/source	- connect all outputs to an input
3)	Connect Audio Output/User to an Input/CPU	- connect an output to an input (audio ports only)
4)	Connect All Audio Outputs/Users to an Input	- connect all outputs to an input (audio ports only)
5)	Change Mute Status for Audio Output/User (not applicable to this unit)	- mute or un-mute the Audio port output
6)	Change Volume for Audio Output/User (not applicable to this unit)	- change Audio port output volume
7)	Read Connection for Video Output/Monitor	-read the connection of a specific video output
8)	Read Connection for Audio Output/User	-read the connection of a specific audio output
9)	Read Mute and Volume for Audio Output/User	- read the volume and the mute status of the specified audio output
a)	Save I/O Connections into Unit Memory	-save the connections into switch memory bank
b)	Restore I/O Connections from Unit Memory	-restore the connections from switch memory bank
c)	Change All Units Baud Rate (9600/COM1:)	-change RS-232 Baud rate of all switches -the current baud rate and serial port are displayed in parentheses
d)	Reset Unit	- send a reset command to the switch - the current unit address is displayed in parentheses
e)	Reset All Units	- send an internal reset command to all switches
f)	Read Unit Size	- read the switch size (number of inputs and outputs)
g)	Read Unit Version/Revision String	-read a string containing the switch version, type, and size
h)	Save All Units I/O Connections into Units Memory	-save the connections into switch memory bank, command for all switches
i)	Restore All Units I/O Connections from Units Memory	-restore the connections from switch memory bank, command for all switches

Selections in the "Key" column that are gray are not applicable to this product.

Setup Options

Key	Selection	Description
1)	select Com port current: (COM1:)	- select PC serial port - the current PC serial port is displayed in parentheses
2)	select Baud rate current: (9600)	- select PC serial port baud rate - the current baud rate is displayed in parentheses
3)	set unit Address current: (1)	- select the unit address - the current address is displayed in parentheses

For any selection that requires user input, the user is prompted. When commands are sent to the VIDMUX, the command string and VIDMUX responses are echoed to the screen. All commands generated by the program are formatted according to the information provided in sections above. If any transmission problems are detected, an error message is displayed.

Press <Esc> or <Enter> to back out to the main menu and press again to exit.

AUDIO SUPPORT

Models with audio support (SE-AV-xx-L/RS) include connections for audio sources and an output device. Audio from either the same sources as the video or from separate sources will be heard through devices such as self-powered stereo speakers or headphones. Connections to “AUDIO IN” ports will switch at the same time as like-numbered “VIDEO” ports when controlling the switch using the front panel (SE-AV-x-L) or when using RS232 control (SE-AV-x-RS). For example, if “VIDEO 1” is switched to “VIDEO 2”, then “AUDIO IN 1” will also switch to “AUDIO IN 2”.

SPECIFICATIONS FOR STRAIGHT-THROUGH RS232 SERIAL CABLE

VIDMUX to PS2 CPU (9 PIN)

VIDMUX 9 pin		Signal Direction	PS/2 CPU 9 pin	
Function	Pin #		Pin #	Function
RxD	3	←	3	TxD
TxD	2	→	2	RxD
CTS	7	←	7	RTS
RTS	8	→	8	CTS
DSR	4	←	4	DTR
DTR	6	→	6	DSR
SG	5	—	5	SG

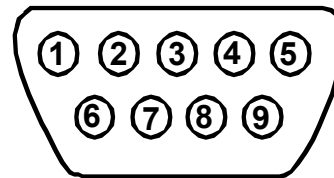

**Mating Face
of a 9DB Male**

Terminals 7 and 8 are jumpered together and terminals 4 and 6 are jumpered together.

TECHNICAL SPECIFICATIONS

Video	
Video Resolution	1900x1200 @ 60Hz
Video Bandwidth	230 MHz
Video Connectors	15HD female connectors
RS232 Connector (“-RS” models only)	9DB female connector
Audio	
Input Frequency	20Hz to 20kHz, +/- 0.5dB
Input Amplitude (max.)	5000 mV peak to peak
IMD	-80 dB
Output Load	32 ohm head phone
Output Current	+/- 250 mA max
General	
Power	120VAC or 240VAC @ 50 or 60 Hz
Size (In.) WxDxH (4 & 8 port model)	11 x 6 x 1.75
Size (In.) WxDxH 16 port desktop model	11 x 6 x 3.5
16 port rackmount	19 x 6 x 1.75

TROUBLESHOOTING

Each and every piece of every product produced by Network Technologies Inc is 100% tested to exacting specifications. We make every effort to insure trouble-free installation and operation of our products. If problems are experienced while installing this product, please look over the troubleshooting chart below to see if perhaps we can answer any questions that arise. If the answer is not found in the chart, please check the FAQs (Frequently Asked Questions) at our website at <http://www.networktechinc.com> or contact us directly for help at 1-800-742-8324 (800-RGB-TECH) in US & Canada or 1-330-562-7070 worldwide. We will be happy to assist in any way we can.

Problem	Cause	Solution
Video Error	Poor cable connection	Check cable connections on video source and switch.
Video changes ports automatically	Unit is in Scan Mode	Press Scan Mode button on VIDMUX front panel. Scan Mode LED should now be OFF
No RS232 communications	<ul style="list-style-type: none"> • Baud rate not correct • Wrong cable used 	<ul style="list-style-type: none"> • Verify VIDMUX and terminal are set to same baud rate Set DIP switches 2,3,4 to ON for 9600. • Use straight-thru cable (see page 4)
No response to RS232 commands	Improper protocol	Verify command string is as described on page 8. Try using the NTI Switch Control Program (page 10)
Unable to listen to Audio	<ul style="list-style-type: none"> • Wrong connection • Volume control • CPU connection 	<ul style="list-style-type: none"> • Check audio cable is connected to same port number where active video connection is made. • Check volume control setting on the CPU • Check that connection between active CPU and AUDIO IN is proper and proper audio port is selected on CPU
Some audio-video ports are not selected during scan	Particular port configured to be skipped in scan list	Change status from skip to no skip in the scan list (see command chart on page 9)
Newly set baud rate changes after power cycle	The desired baud rate was set using RS232 (see page 9)	To change baud rate such that it is unchanged after power cycling, change dip switch settings (see page 7) .
The audio-video cannot be heard/seen after power cycle	At power up, the default port selection is Port 1 and a different port was connected before the power cycle	Make a port selection back to the desired port

INDEX

audio connections, 5	RS232 Commands , 9
Audio support , 12	RS232 connection, 4
Autostatus , 10	RS232 Control , 7
baud rate, 7	Scan Mode , 6, 10
cable connections, 4	SerTest, 11
NTI Switch Control Program, 10	Troubleshooting , 13
Rackmount ears , 3	unit address, 8
RS232 cable, 7, 12	

WARRANTY INFORMATION

The warranty period on this product (parts and labor) is two (2) years from the date of purchase. Please contact Network Technologies Inc at **(800) 742-8324** (800-RGB-TECH) or **(330) 562-7070** or visit our website at <http://www.networktechinc.com/return-policy.html> for information regarding repairs and/or returns. A return authorization number is required for all repairs/returns.

PRODUCT

SERIAL NO.: _____

DATE: _____ **INSPECTED BY:** _____